





SETTING UP

<p>STEP 1 Power on the camera.</p>	<p>STEP 2 Connect your smartphone to the 2.4GHz WiFi network.</p>	<p>STEP 3 Download and install the AztechRaptorVue app from Apple App Store or Google Play.</p>   	<p>STEP 4 Launch the app, and tap Sign Up to register an account.</p> 
---	--	---	---

4

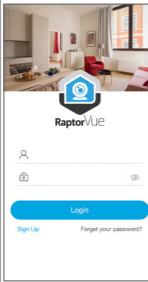
<p>STEP 5 Tap + to add new device after logging in.</p> 	<p>STEP 6 Scan the QR code on the back of the camera to get the serial number. You can also tap Serial number adding to enter the serial number manually.</p> 	<p>STEP 7 Ensure your smartphone is connected to the same WiFi network, then tap Next.</p>	<p>STEP 8 Enter the WiFi password, and tap Next.</p> 
---	---	--	--

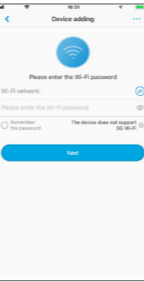
5

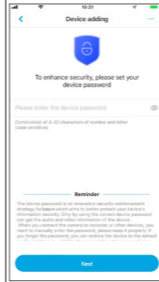
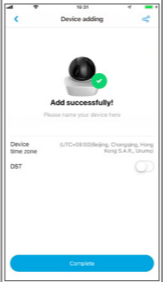
<p>STEP 9 Enter your device password.</p> 	<p>STEP 10 The camera is successfully added. Set up your time zone and tap Start Live Preview.</p> 	<p>NOTE</p> <ul style="list-style-type: none"> To add another camera, repeat Steps 5 to 10. To change the WiFi network, factory reset the camera and repeat steps 5 to 10 to add camera.
--	--	---

6

INSTALLING THE DEVICE

NOTE
Ensure the installation surface can support three times the weight of the camera and bracket.

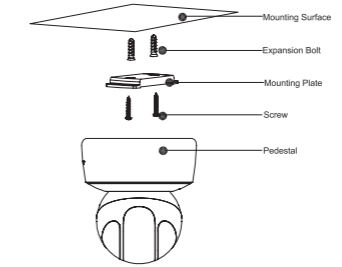

- STEP 1**
Drill into suitable mounting surface according to the holes on the Installation Board.
- STEP 2**
Secure the expansion bolts into the holes.
- STEP 3**
Use the self-tapping screws to fix the Installation Board.
- STEP 4**
Power up the device.
- STEP 5**
Adjust the camera angle and attach the device on the Installation Board.

7

Aztech

RaptorVue WIPC680QHD

2K Cloud Camera

EASY START GUIDE



PLEASE KEEP THIS EASY START GUIDE FOR FUTURE USE.

DISCLAIMER

- This Easy Start Guide is for reference only. Minor difference might be found in the user interface.
- All the designs and software here are subject to change without prior written notice.
- All trademarks and registered trademarks mentioned are the properties of their respective owners.

PACKAGE CONTENTS

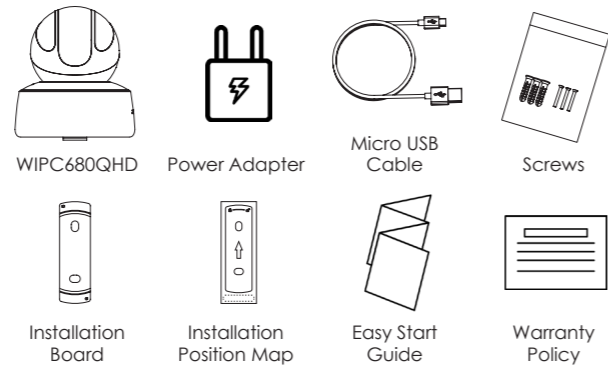

1

COMPONENTS

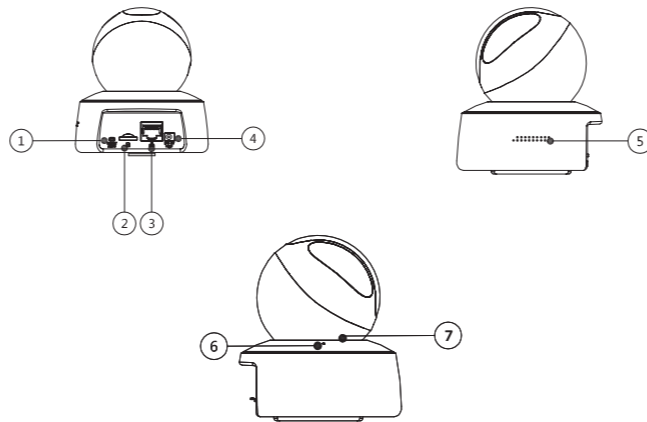

2

NO.	COMPONENT
1	Reset/WPS (WiFi Protected Setup) button
2	Micro SD card slot
3	Network port
4	Power port
5	Loudspeaker
6	Microphone
7	LED indicator light

NOTE:

To reset, press and hold the Reset/WPS button for 8 seconds until the LED turns off.
For WPS, press the Reset/WPS button once.

LED STATUS	DEVICE STATUS
Spinning red	Booting up, fail to boot up, device malfunctioning
Spinning green	Booting up complete, awaiting WiFi configuration, entering smart configuration status
Blinking green - slow	WiFi smart configuration in progress, including WPS, management frame, etc.
Blue - on	WiFi connected, operating
Blinking blue - quick	Updating device
Blinking yellow - slow	Network disconnected
Blinking red - slow	Fails to boot up, SD card is not working

3

AZTECH TECHNICAL SUPPORT DETAILS

User Guide

<https://www.aztech.com/categories/aztech-datacom/ip-camera>

Product Registration

<https://www.aztech.com/aztech-support/product-registration>

Customer Care

<https://www.aztech.com/service-centre>

Service Centre Address

31 Ubi Road 1, #01-05
Singapore 408694

Operating Hours

Monday to Friday: 9:00 AM to 6:15 PM
Saturday: 9:00 AM to 1:00 PM (Except Sunday & Public Holidays)